

# Kid 🐉 Blackhawk10



## **Will RUSSIA Join The Fray?**

by Kevin Ahearn



**'KID BLACKHAWK 10'** is fiction.  
All references to actual persons, alive  
or dead, made for a good story.

**“JUNIOR” JOHNSON.....MARLON BRANDO**  
**“CHOP-CHOP” .....KEYE LUKE**  
**BLACKHAWK.....ROBERT REDFORD**  
**ZINDA BLAKE.....MERYL STREEP**  
**JJ III.....TOM CRUISE**  
**KABAKOV.....ARNOLD SCHWARZENEGGER**

**PLUS AN ALL-STAR SUPPORTING CAST**

***Blackhawk*** created by Chuck Cuidera, Bob Powell, and Will Eisner

***Lady Blackhawk*** and "Junior" Johnson created by Jack Schiff and Dick Dillin

***Blackhawk*** is the property of DC Comics

**Cover: Arnold Schwarzenegger Red Heat**



1



PEACE

Through Superior Firepower

via MotivatedPhotos.com



*'You get what you tolerate.'*

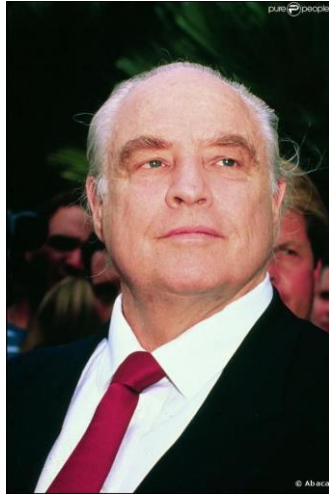

November, 19, 2013

**My Journal:**

*The day after 'Meth Tower' came down, my son, whom I love with all my heart, came to see me.*



*To admit, of course, that...*



**Not quite...**

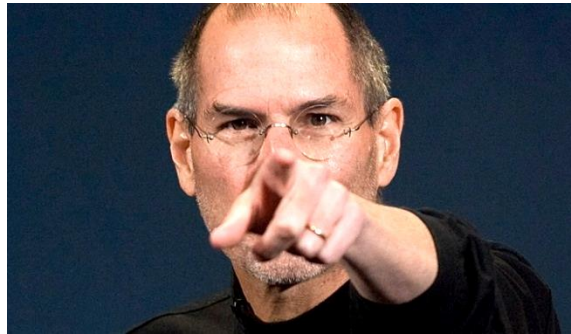

*'Fantastic! Incredible! Do you know what you've done?*

*'What were you thinking?  
What do you want them to do?'*

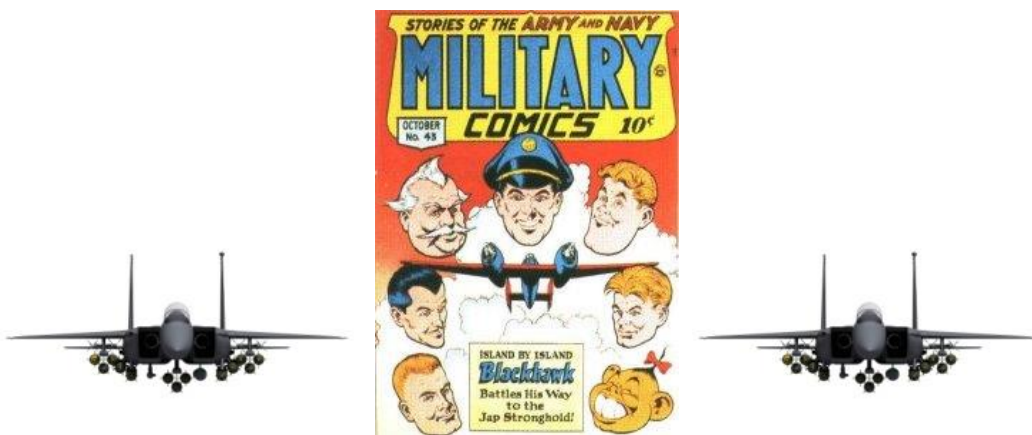

***I winked and shook my fist; Lady Blackhawk would have been proud.***

***"Hawk-A-A-A-A!"  
'Junior' Johnson***

**Real Time**





*'So far, so good.'*

*'Because nobody knows where we're going!'*

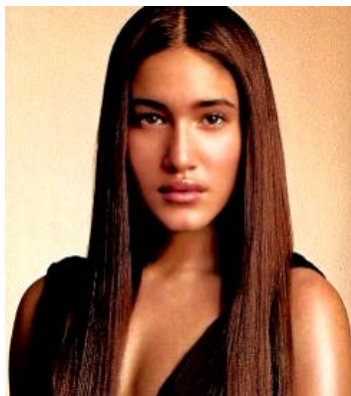

*'Activity swirling around! The US, the Saudis, Israelis, the Russians, Iraq, Iran and Syria, not to mention the Chinese!'*



*'But no fighter aircraft in the air yet!'*



'All systems five-by-five. Playing it cool to go hot!'



'Gorgeous day for a fight Or a picnic!'



'Weather and surprise! Our favorite allies and we have neither.'



"Allies"...after this raid?"

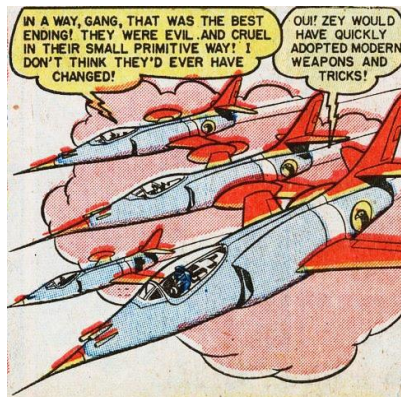

'Only way to find out who our real friends are!'



"The Blackhawks do not hit secondary targets"! Who and where?'



*'With the Queen of England's petrol! You've heard the rumors, the Wartime gossip, about the Hero and the Princess?'*



*'The two did meet, and talk. But beyond shaking hands, they never touched. That didn't stop the wartime tabloids from pumping out romantic propaganda!'*



*'As made up as the Loch Ness Monster and Irish Leprechauns. Like magic, the story began to roar---the public bought into it!'*



*'The provocateur press turned on him faster than a Nazi Messerschmitt, re-imagining the 'Archangel of Vengeance' as a skirt-chasing lout!'*





*'Ready for a "new beginning"?'*



*'Most men lead lives of quiet desperation and go to the grave with the song still in them.'*

*'How about becoming...an "Angel of Vengeance"?!'*



*'Living in a tropical paradise in a plush beach house. Wake up in the morning beside your beautiful, loving wife, play with your wonderful children. Then hop in your jet and fly off and bomb somebody!'*

# VOGUE



20TH CENTURY 10

# People

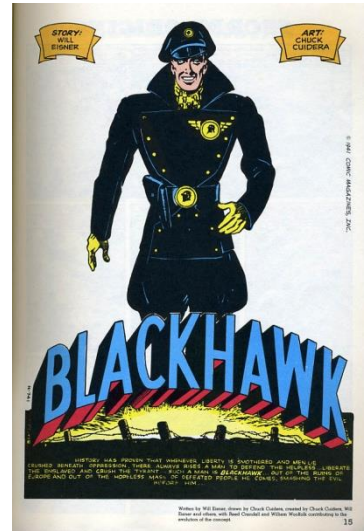

THE *SEXIEST* MAN ALIVE!



*'Kid Blackhawk is invincible as a unit!'*



*'The greatest threat to lazy children ever known!'*

*'With a tagline!'*



*'No.'*



*'And everybody, well almost everybody, cheers!  
These guys are brave and bold and hunky gorgeous, and  
'politically correct'. What's not to love?*

*'The "Angels of Vengeance" have had historical haters.  
Gotta be doing something right!*



*'Doesn't anyone see what's really happening?'*



*"Over land, over sea, we fight for liberty, we're **Blackhawks!**"*

**Giving the World...**



**The Bird!**



*'Parliament commends your loyalty, Your Majesty, but a few question your prudence.'*



*'Only "the few" who have yet to understand the "Angels of Vengeance"! In 1941, six white men from a continent overrun by the Nazis, and a cute Chinese cook, his country ravaged by the Japanese Empire!'*



*'The **Blackhawks** symbolized unity versus merciless enemies, but this new diverse "community" without a single European...'*



*"It takes a village."*



*'The "Angels of Vengeance" possess a living pillar of strength: the family!  
Still one of "the few", Prime Minister?'*

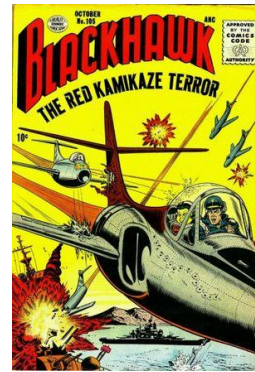
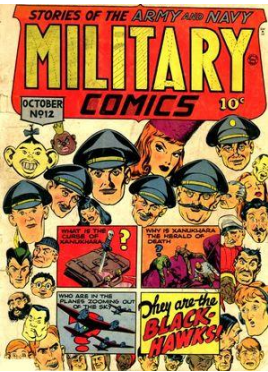

*"Show me **Blackhawk!**"*

**CenterCityChronicle.com**  
**TARGET FOR TODAY!**



**TROUBLE FOR TOMORROW?**

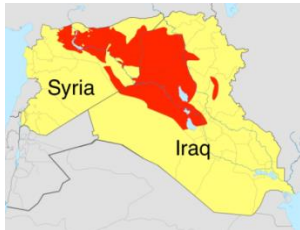

*'The liberty-loving **Blackhawks!** Free to attack whomever and wherever, whenever they want!*

*'This cannot go on!'*

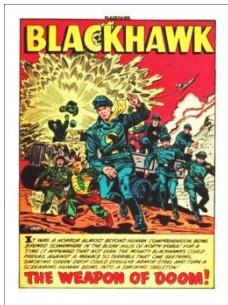

*'Russia must be a superpower, its influence felt globally! ISIS has to be wiped out even if it means cooperation with the United States and Iran.*

*'The key is the 'legitimate' state of Syria. Prop up the besieged dictatorship with a Russian 'presence', a stepping stone into the Middle East!*



*'We will keep the Civil War going and millions of refugees fleeing to Europe. The perfect distraction for his army to restore Russian might in the Crimea!*



*'What do the **Blackhawks** want?  
What are they after?'*



*'Public approval! Free and independent 'show-offs!  
Untouchable at altitude, they'll bomb ISIS or Al-Queda or  
the Taliban to win the favor of the democracies. A PR mission!'*

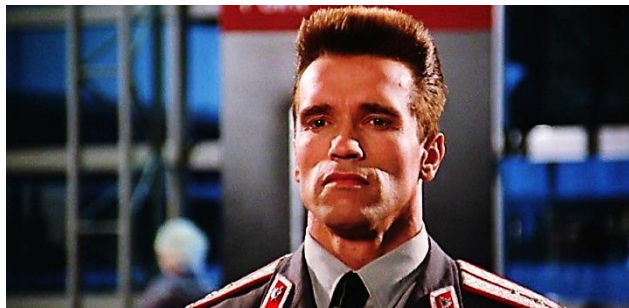

*'Nyet! Bomb these Arab thugs "back to the Stone Age"?  
ISIS is the Stone Age!'*



*'Colonel Kabakov, commander of the elite **Kremlin Knights**.  
Put yourself in the place of the 'Archangel' of Vengeance'...  
Whom would you attack?'*

Kabakov studied the map with a pilot's eye.

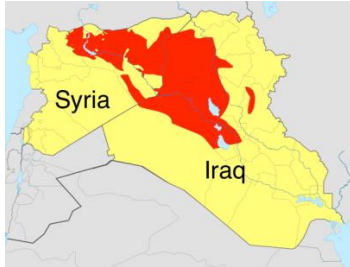

*'Mister President, only one target that will make a difference: Us!'*

**f Abasi** 



"As-salam alaykum-

"I'm not as old or as big or as smart as the other children on *Blackhawk Island*. Not yet!

[I can't speak English or write anything. Mama helped me a lot.]





We *Kid Blackhawks* live on a magical place. And by pushing buttons, find out anything.

Including *Blackhawk* history...



We want to raise and train our own hawk like '*Blackie*' who became a hero when the team fought the vultures!



We've done a lot of '*searching*' and '*researching*'. We want our mascot to be safe and happy. But there are no rabbits or mice around here. But all kinds of delicious fish.



Our '*Blackie*' could never live in a cage.

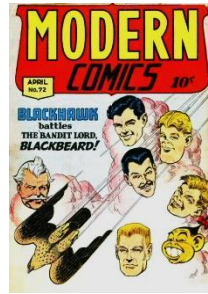

Like everybody on *Blackhawk Island*, our mascot must be free.

"HAWKA-A-A-A!"



Initial Point - Dead Ahead. The point of no return. To abort now would be **'Blackhawk-ing it!'**



*'Behold the unsuspecting sky.  
Like being in an epic poem  
I'm dying to read!'*

*'Or a reboot of our  
favorite movie!'*



*'Bombing people, with the risk of killing women and children will never be a **Blackhawk** "adventure". Ah, but destroying weapons...'*



*'This doesn't get done unless the **Blackhawks** do it. No winning in a chaotic mess, but maybe we can shorten this "Game of Thrones" by taking out one of the players.'*



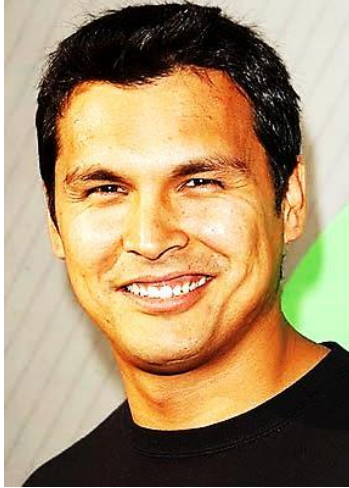

*'I have achieved my vision.  
To fight to make people free!'*



*'It's like déjà vu all over again.'*

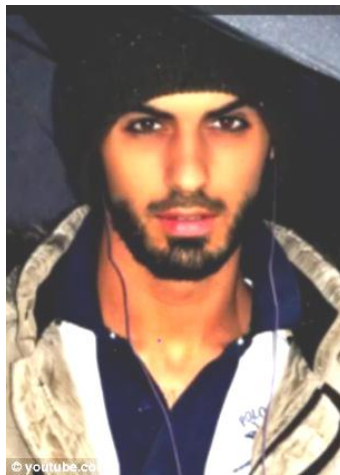

*'Allah is great! But no God wants the people  
he created to kill each other!'*



*'Ladies and gentlemen, and children of all ages!  
Prepare yourselves for our feature presentation...'*

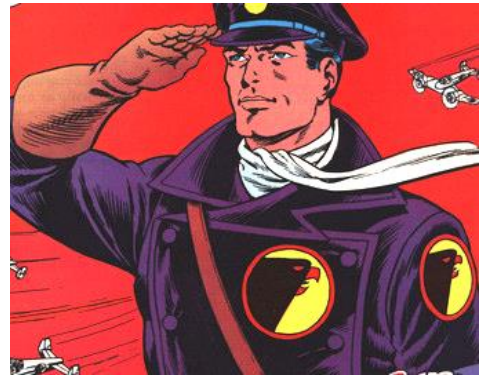
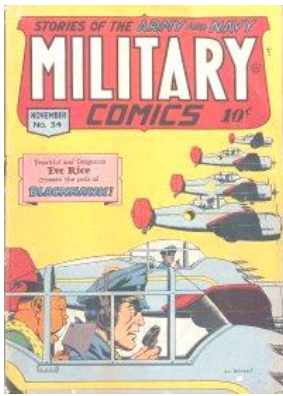

**THE BLACKHAWKS DO SYRIA!**

# 2



*'There are nine orders of angels, to wit, angels, archangels, virtues, principalities, dominations, thrones, cherubim, and seraphim.'*

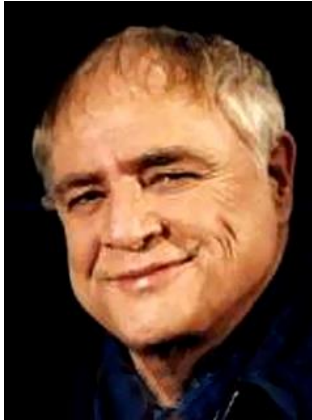

April 11, 2014

My Journal:

*The Blackhawks stopped a war in the Persian Gulf before it could start!*



*Saved American drivers billions at the pump. Won a huge pay-out from Big Oil. My 'business man' son was impressed and delighted.*

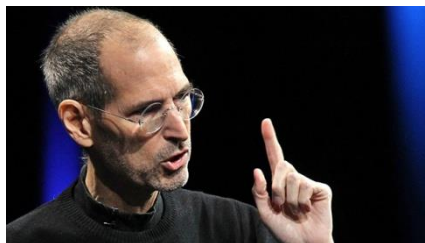

*'Congratulations, Dad! Your 'Angels of Vengeance' shot down and sank the bad guys at the cost of their own planes.*

*'Let's face it, without aircraft the Blackhawks are stuck out of sight, and out of mind. They'll be old news in a month!'*

Nope. He still doesn't believe.

"HAWKA-A-A-A!"  
'Junior' Johnson

Real Time



'Syria! The 'Angels of Vengeance' would challenge an entire country!'

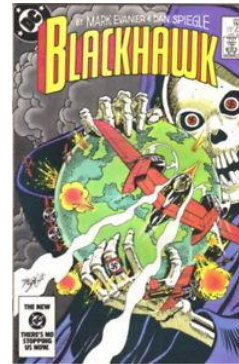

'Who are those guys?'

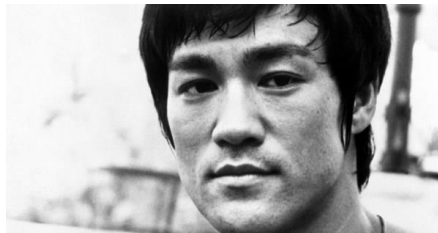

'I should have known. The **Blackhawks** are not yet another power bombing ISIS.

'Al-Quaeda has become a secondary target!  
Only one jackpot...outside Demascus...'





*'The Palace of Bashar al-Assad!'*



*The "Angels of Vengeance", alone against my nation!  
Fire at will the moment they cross the border!"*

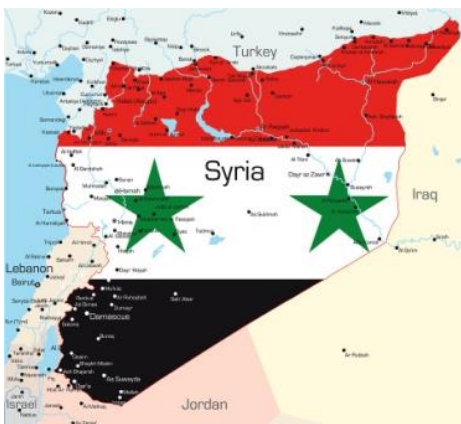

Hardly a surprise attack, the Syrians had been on alert since the **Blackhawks** entered Iraq.

Via *satelligence*, Air Defense appeared to be a first-rate network with scores of SAMs and dozens of fighter planes, fully capable of meeting an enemy attack...from the Saudis, the Iranians, but most of all, the Israelis!



Closer examination revealed a disjointed and fractured organization buckling under the Civil War raging since the 'Arab Spring', four years and 250,000 lives ago.

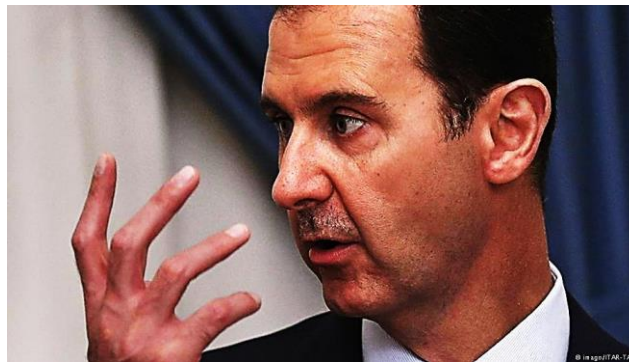

'Should any survive...  
Easy prey for my **Vultures!**

**f Medina** 



"Marhaba---

"My family and I live on an island as magical as *A Thousand and One Arabian Nights!*

"*Blackhawk* history is full of fantasy!

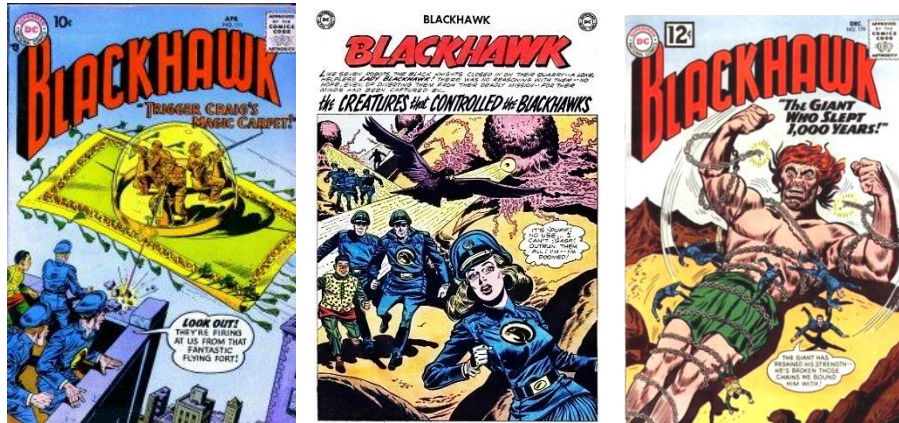

"We all work very hard, but because we're united in purpose, there's an easiness in life. Learning, learning and learning, every day is a new adventure.

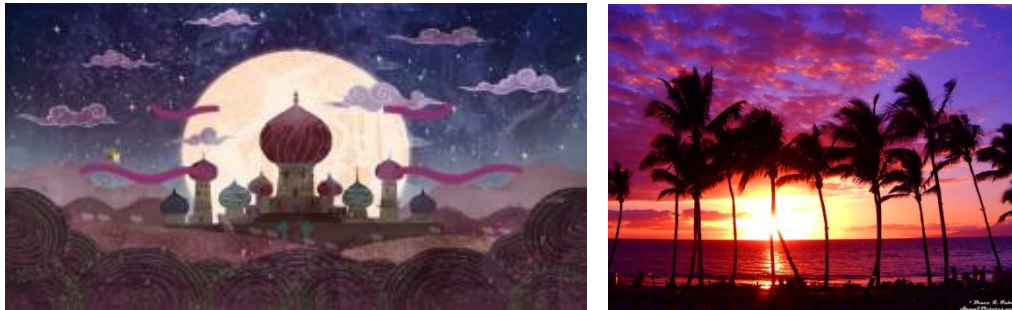

"The only difficult time for us *Kid Blackhawks* begins with the reality of the coming mission.



"Full team breakfast, then the flight-prep. It's the last time I see my father before the canopy closes..."



"That's hard.

**"HAWKA-A-A-A!"**

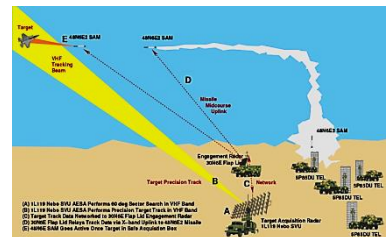
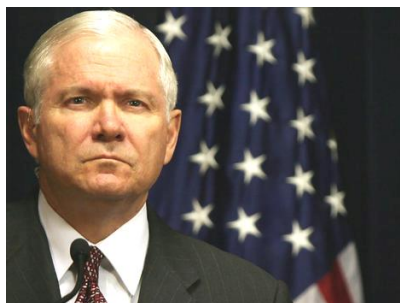

*'The F-15SE! The "Angels of Vengeance" are flying America's best! With enhanced stealth, decoy flares and full-bore electric counter-measures, all the bells and whistles. Against an aged Russian defense system manned by illtrained Syrians!'*

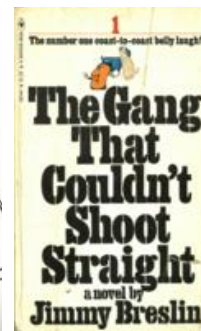

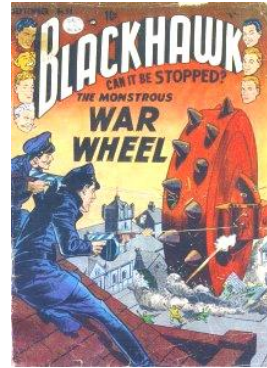

*'Just like old times! In their prime, the **Blackhawks** toppled dictators from Eastern Europe to the South Pacific.'*

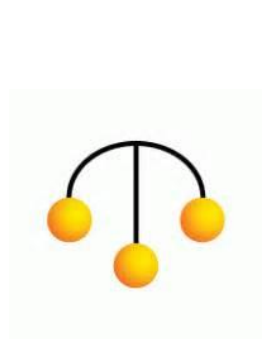

*'The **Blackhawks** are invincible as a unit!'*

*'The greatest threat to unauthorized editions ever known!'*

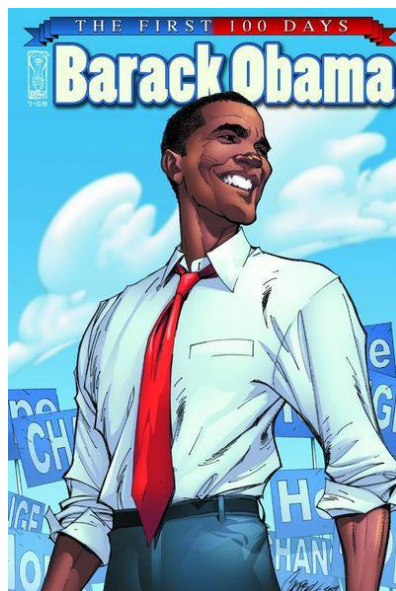

*'Their mission...'*

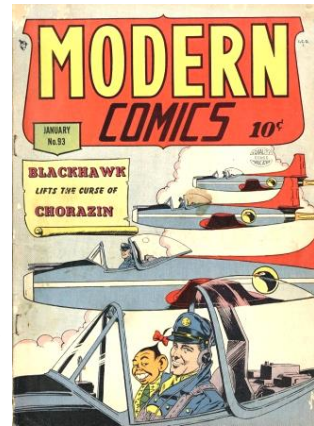

*'To do what every other nation with a conscience should have done years ago - Syrian regime change!'*

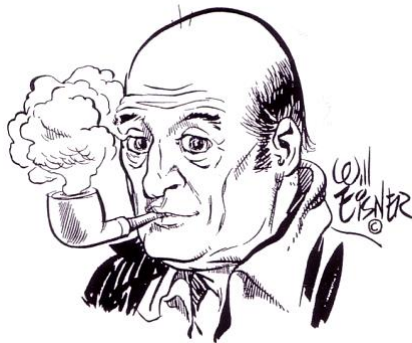
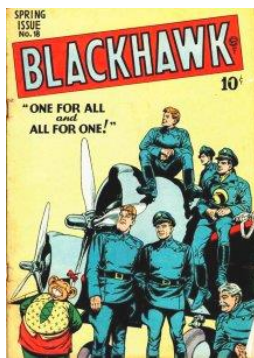

*'The Blackhawks belong in WW II. Not in the modern world. But I wish them the best of luck.'*



The United States is a quilt of 3,143 counties. The Pine Ridge Indian Reservation in South Dakota is the poorest.

At the meeting of the Oglala Tribal Council...





*'Hi. I am Anpaytoo and I want to open a factory on the reservation.'*

*'To silkscreen T-shirts and sell and distribute them around the country!*

*'I've talked with Wicasa...'*

*'Oh, he's the son of Kin-Yon, "Sapa Ceta."'*



*'Did you say factory?  
For what?'*

*'And how will that happen?'*

*"Wicasa"?"*



**'The Blackhawk?'**



*'You've been in contact with the  
"Angels of Vengeance"?'*



*'The **Kid Blackhawks!** The financing and tech support are already done. With your approval, the equipment will be delivered and we can start screening a whole set of different colors and exclusive emblems!'*





*'Kid Blackhawk is invincible as a unit!'*

*'The greatest threat to child abuse ever known!'*



*'Please understand that it will be our jobs, yes, jobs! We've got to prove that the Oglalas are honest, hardworking dependable workers who will take great pride in our success!'*

*'With your approval...'*

For less than a minute, the Tribal Council whispered among themselves. then...



**'Show us Kid Blackhawk!'**





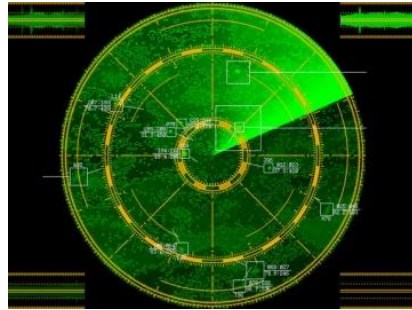

*'They're firing every SAM they've got!'*

*And batting zero!'*



*'A Syrian shooting gallery!  
Our combined ECM is  
goosing the SAMs!'*

*We've given them an extra  
shot from here. Bounced off  
a US spysat!'*

*The Syrian C3 system is an  
old joke! Overreliance on  
vulnerable communications  
networks...'*



*'And its centralized air battle management construct  
make its innards ripe for electronic attack!'*

*'But not all! If radar 'paints' them...  
They're out of flares!'*



**'Blackhawk luck! We need you now!'**



At 60,000 feet at Mach 1.6.



*'A fireworks show! If Syria is ever free, this could be the beginning of the celebration!'*

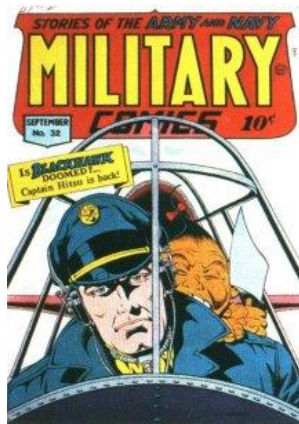

*'More SAMs coming up! SA-5 high-altitude jobs.'*

*'If they pick us up on radar, we're cooked!'*



*'Half a dozen! Locked on or are they just guessing?'*



*'Let's not eject just yet. Time to go fishin'.'*



Syrian Air Defense was striking out across the board until...

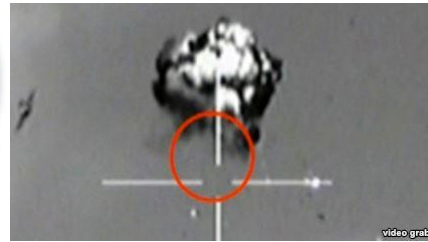

*'We have them! Their ECM jamming has malfunctioned!'*

*'Missiles tracking! Al-hjumdoolillah, a hit!'*

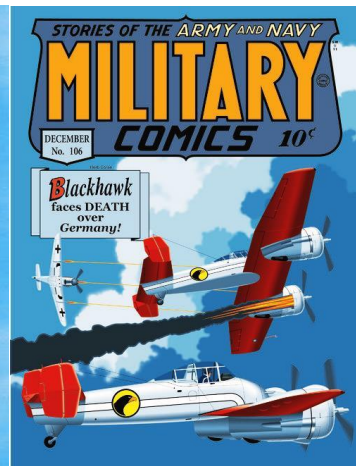

Six hits, the crude imagery instantly going viral.

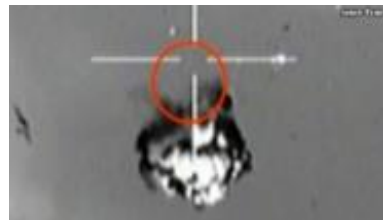

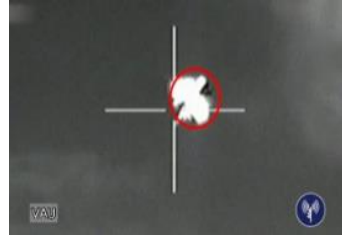

Concern gripped the world...



But not everyone.

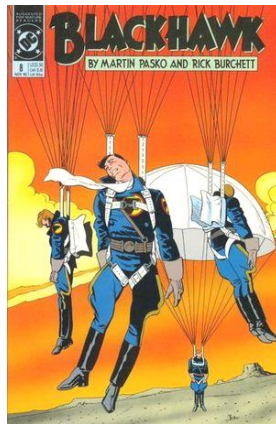

# 3

Copia gentilmente concessa dal Ministero dell'Informazione della Repubblica Araba di Siria



*'As Syria goes, so goes the region.'*



November 19, 2014

My Journal:

*God Bless John Zacherley, that crazy wonderful kook  
Lived to the very last moment of his life.*



**BIGGEST SHOW IN HISTORY!**



*The Blackhawks are 'household names'!*

*The team got their new jets. The sky's the limit!*



*My son had a different take...*

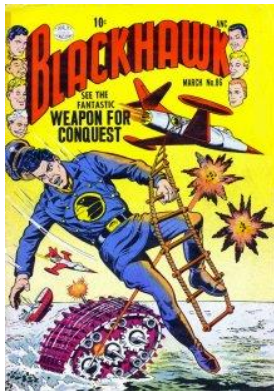

*'When **Blackhawk** saved your life, you met the whole team, and felt like being with the immortals of your time...*



*'Can't you see who your 'Blast from the Past' heroes have become?*





*'Mega-Media-Stars! Forgettabout your 'Angels of Vengeance' making the world a safer place. Their constant combatants won't be dictators and drug lords, but crazed fans and the paparazzi!'*

*There's just no persuading him.*

**"HAWKA-A-A-A!"**  
 'Junior' Johnson

**Real Time**



*'We can only confirm that the data received is from a Syrian radar installation.'*



*'It appears, appears, that something exploded in the Syrian sky. Six explosions altogether and Syrian Air Defense is claiming to have destroyed a formation of foreign aircraft that had violated their air space. No debris or bodies have yet been recovered.'*

*'Have the **Blackhawks** been killed? Is this the inglorious end to the 'Angels' of Vengeance?'*

*'There are other questions...'*

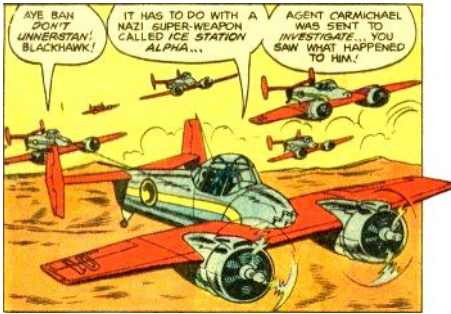

*'Should an independent fighter squadron be allowed, encouraged even, to fly around dropping bombs wherever they see fit?'*

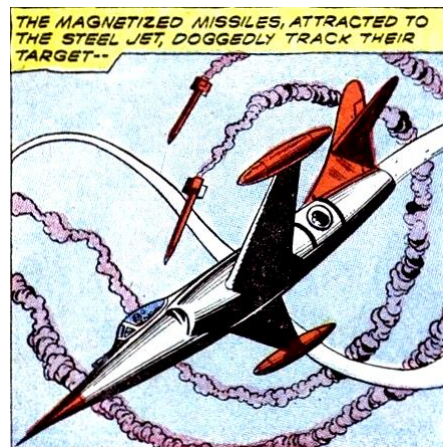
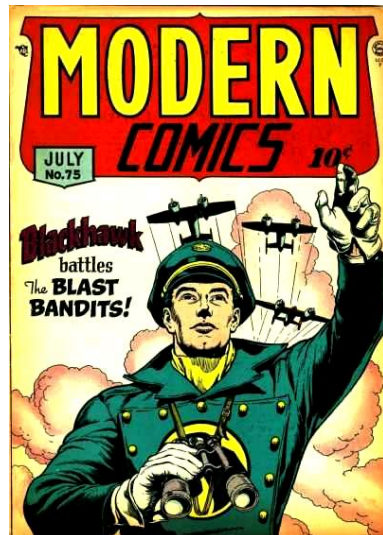

*'"Global gunslingers", "International lynch mob", will the world be better off without the "Angels of Vengeance"?''*



"Ho!a!

"I'm a 'Young Angel of Vengeance'!



'I didn't 'get to be' - I wanted to *become* a Blackhawk!

'The process begins with belief - our fathers are the greatest fighting team in the world!

'Reading, studying, learning...the Kid Blackhawks are a part of the mission, too.

'we're doing the right thing! And we're gonna keep doing it! Nobody can beat the 'Angels of Vengeance'!

'we're with the team every step of the way. And when my Dad is flying, I feel like I'm in the cockpit with him.



'Do you think, for a minute, that I'm going to believe, that my father, 'El Halcon De Oro', has been shot down by some low-tech Russian/Syrian missile?



'BLACKHAWK Luck!

' HAWKA-A-A-A! '



*'Colonel Ziang! You championed the "Angels of Vengeance" as invincible...and the lowly Syrians shot down the lot of them!'*



*'Or so we saw! Those explosions were not jets, but fiber-optic towed decoys!'*



*'Not unlike a fishing lure. The **Blackhawks** 'let out the line' -- the SAMs 'bit' on it!'*



*'As did I. Then...they're still alive?'*

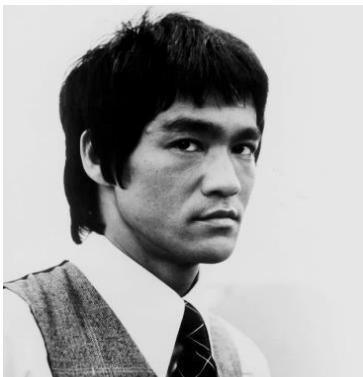

*'Very much so. The Syrians have scrambled their Vultures!'*

*'The Arabs have the numbers!'*



*'So did the Polish cavalry!'*



## COMBAT DIARY



MIG-21PF '5220' in current Syrian Air Force insignia



The F-15 first went into action in March 1978, flying cover for Israeli ground operations against [Palestinian terrorists](#) in Southern Lebanon.

On July 27, 1979, 8 Syrian MiG-21s challenged the new 'air superiority' fighter. Five were shot down in a hurry. From that day on, the F-15 has ruled the Middle East sky.

With no plans to abdicate.

**PLAYBOY**



**Esquire**



*'The 'Angels of Vengeance' beat the missile gauntlet!  
The Syrian Air Force is up and closing.'*



*'What are the **Blackhawks** thinking? According to the Aussies, they're loaded up with cluster bombs, not what you'd want to bring to a dogfight.'*



*'Then they're not after Al-Assad?'*



*'No! The "Angels of Vengeance" never flew assassination missions, not even in World War Two.'*





*'The **Blackhawks** are invincible as a unit!'*



*'The greatest threat to Fascism ever known!'*



*'Then what the hell are the **Blackhawks** trying to do?'*

*'Why? The Syrians...'*



*'My God! Mr. President, I recommend we go to DefCon Three.'*

*'Window-dressing! Always has been! The only way to limit this war is to take out a major player, an arch **Blackhawk** foe...!'*

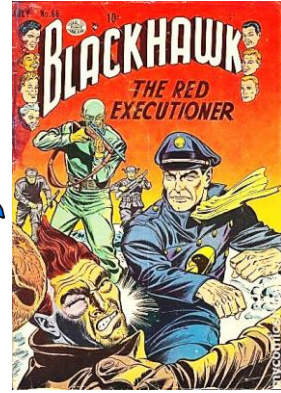
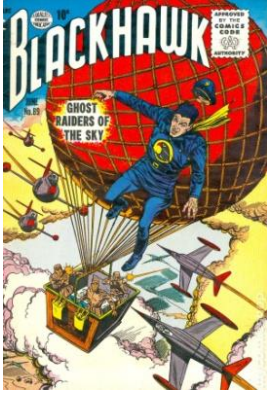

## BREAKING NEWS!



*'The 'Angels' of Vengeance' are alive and well and flying high! High-tech decoys fooled the Syrians and us.*

*'Shouldn't we have known better? These are not our fathers' 'Magnificent 7' or 'Junk-Heap Heroes'...*

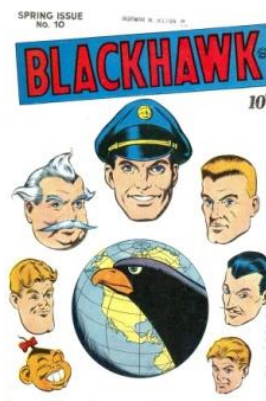

*'But our grandfathers' 'Angels of Vengeance' who fought against the Nazis, the Japanese and the Communists and emerged triumphant!'*



*'And now?'*



*'Bring on the Syrian Air Force!'*



The Syrian Arab Air Force first flew in 1948. They flew primary Russian MiGs in wars against Israel and had known nothing but failure.



Not until the 2012 Syrian Civil War did the Air Force win its wings and wear its insignia proudly. Finally they could be winners, but not in combat--bombing and strafing those would overthrow their dictator.



The *Vultures*' specialty was 'barrel-bombing' civilians. Filled with explosives wrapped in nails, the attacks spread terror throughout Syria.

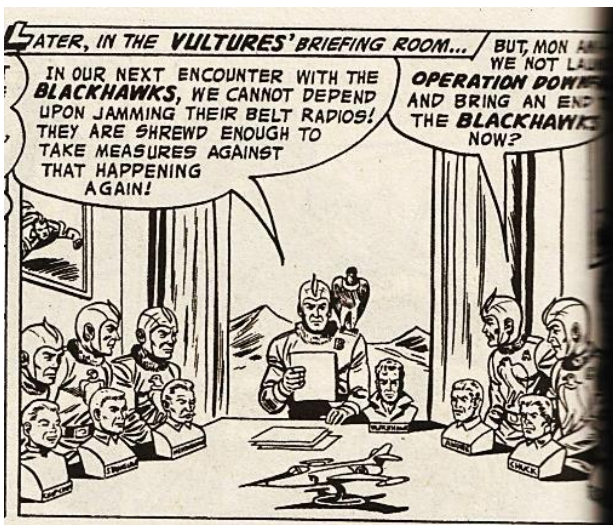

*'Allah is great! Fly high and hard, my Vultures... Above and beyond is redemption and respect! We defy the "Angels of Vengeance"!'*



Ten minutes from the target, the **Island** called...



*'Company coming up!'*



*'Sixteen Vultures!'*



*'An "animal" squadron! The more things change...'*



*'Four finger-four formations around the clock. The Vultures would trap us?'*



*'Wong and I'll take the twelve o'clock group. Darius and Kin-yon, six o'clock, Camilo and Ahmed, nine o'clock. Jacob, you've got three o'clock alone.'*



'Coordinate long-range AMRAAMs! No two stones for one bird. Enseña me **Blackhawk!**'

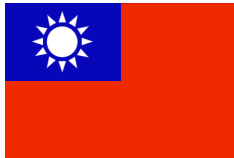

'Hello, great grandfather, I hope you are feeling well.'

'I am, Mei But aren't you worried...the Vultures?'





**'Kid Blackhawks** never worry.  
Our radar can spot them, lock on,  
and we'll fire before those 'Turkeys'  
know what hit them."

'Yes, but...'

"A **Blackhawk** missile never misses",  
you taught me that.  
I want to discuss business.'

**'Blackhawk Business?'**

**'Kid Blackhawk** business!



**'The Kid Blackhawks** are  
invincible as a unit!'

**'The greatest threat to the  
exploitation of children ever known!'**



**'Let's open a t-shirt shop in Taiwan!'**





From 30 miles away, before the MiGs' radar could find them, the **Blackhawks** fired a barrage of missiles around the clock.

The viral "highlights" came from Syrian cell phones.

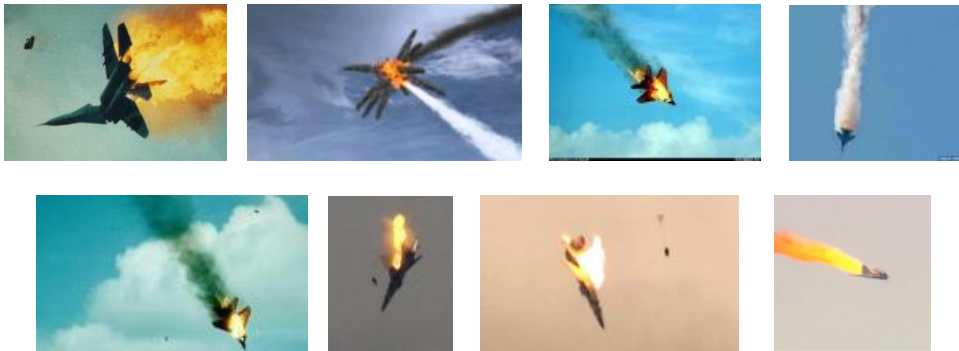

Half of the pilots ejected safely. The others did not.

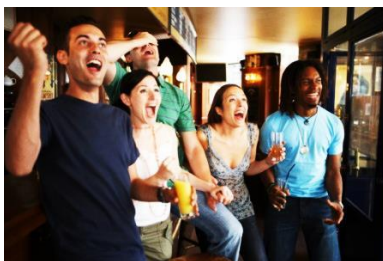
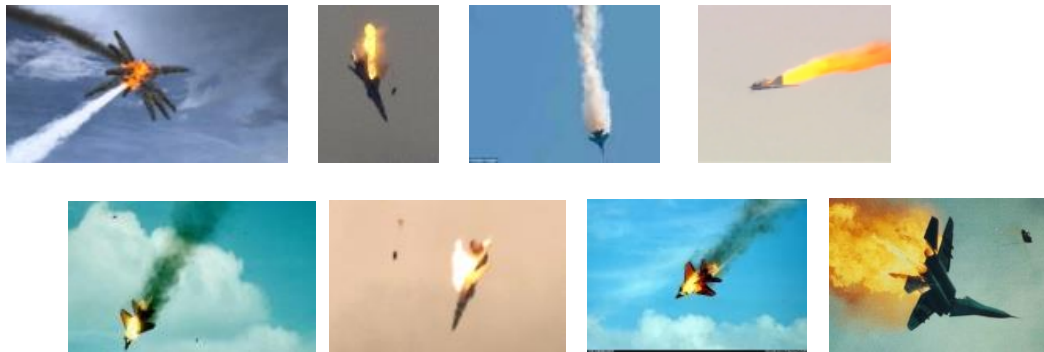

*'Show me Blackhawk!'*



0 



16 



*'An overwhelming performance by the 'Angels' of Vengeance'. The Syrians didn't belong in the same sky.'*

*'The Vultures outnumbered the **Blackhawks**, surrounded the **Blackhawks**, and then...Whoop!*

*"A **Blackhawk** missile never misses."  
The dynasty is back!'*



*'Victory in the "Vulture Bowl"- a **Blackhawk** Blow-out!*

*'Next!'*



Time seems to walk flying a bombing run. Every moment something to see, to do, to feel. The **Blackhawks** had been in Syrian air space for less than five minutes.



*'Targets dead ahead.  
Lined up like in a video game.'*



*'Surface wind negligible.  
Little or no drift.'*



*'Everybody gets their own sector.  
Think the Aussies have a pool  
on the final tally?'*



*'I hope the Syrian refugees get to see  
this. No longer afraid to look up in the sky.'*





*'Clear to morning. We'll be long gone before the firestorm hits!'*



*'We've just begun. Let this be the beginning of the end!'*



*'Bombs away, world, courtesy of the "Angels of Vengeance"!'*



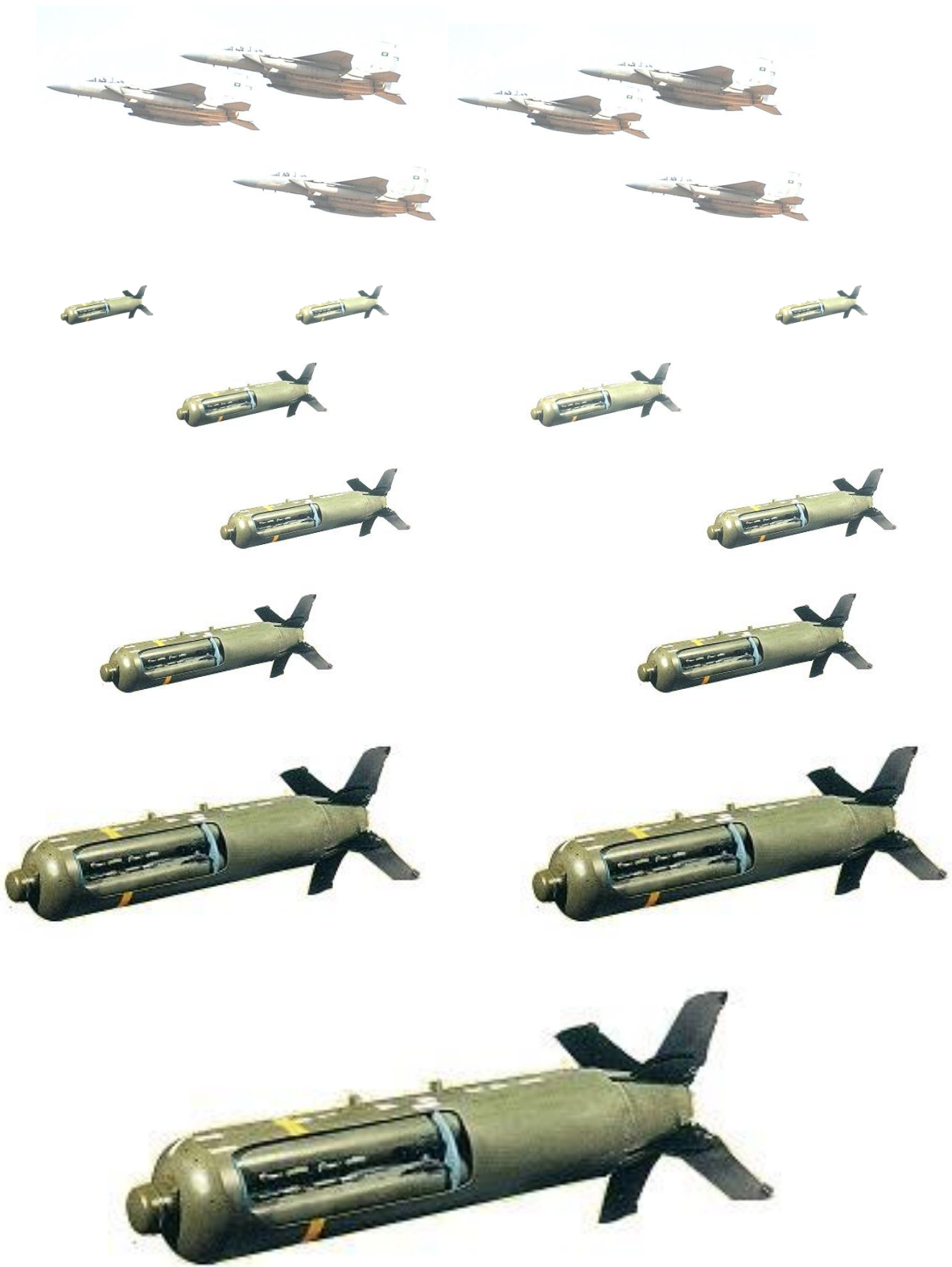

# 4

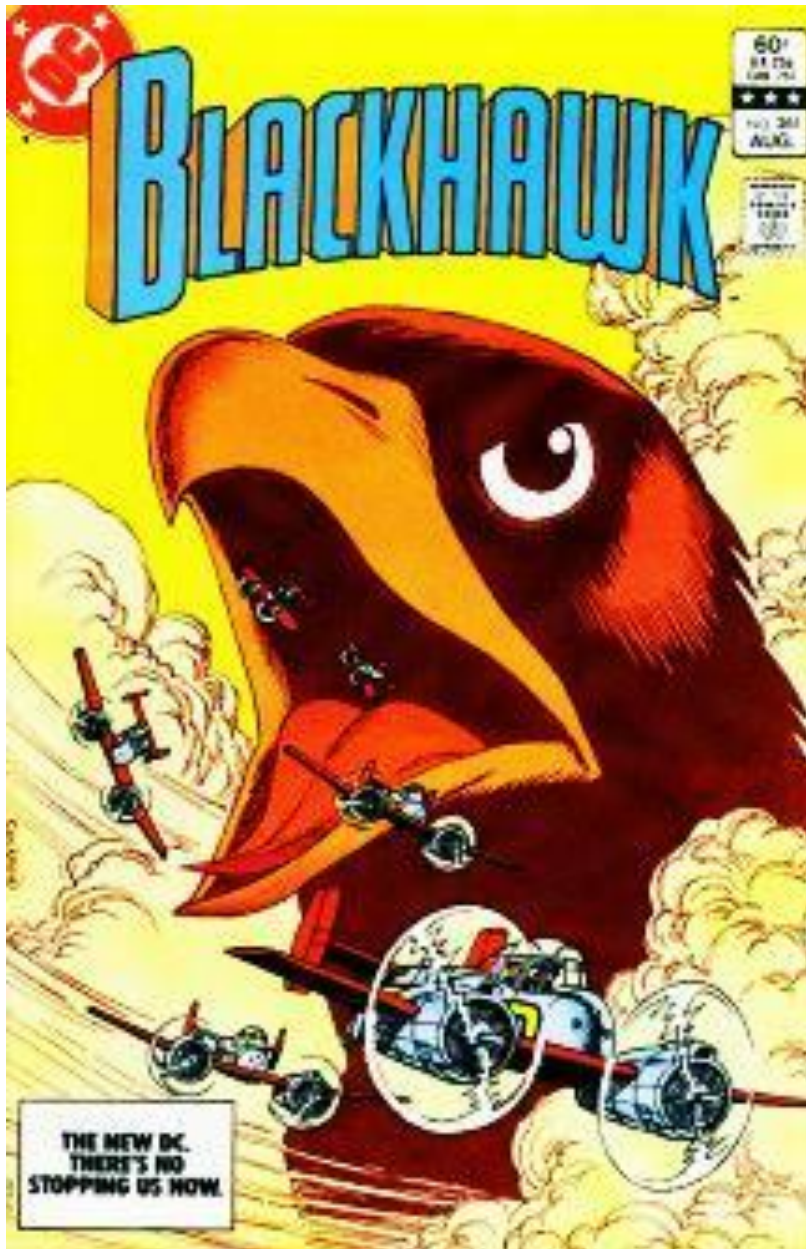

*'Talent wins games, but teamwork and intelligence wins championships.'*



## REAL TIME

### My Journal:

*My health isn't what it used to be. Doctors tell me it's my heart, give me meds and tell me to take it easy. I obey; got so much to live for.*



*The Kid Blackhawks want to do all kinds of things.*

*A screech just outside. My son in his fancy sports car.*

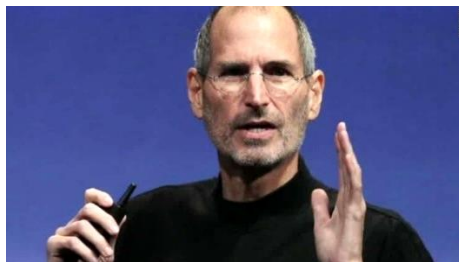

*'Holy smokes, Dad! My son is about to bomb Syria!'*



*'Well, can you blame him? The 'Angels of Vengeance' were flying peacefully across the Middle East. But the moment they entered that brutal dictator's air space, missiles and MiGs--they tried to kill them!'*

*'The **Blackhawks** never turn back!'*



*'Dad, please. Wake up! Your quest is out of control. Call Jay-Jay and end this!'*

*'Don't show me **Blackhawk**, Dad! How about some straight-up truth!'*

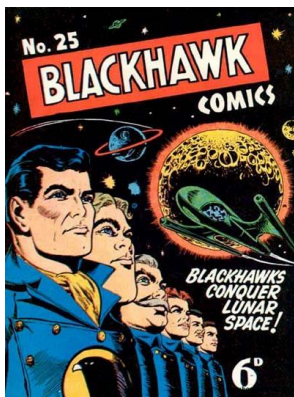

*'The **Blackhawks** are invincible as a unit!'*

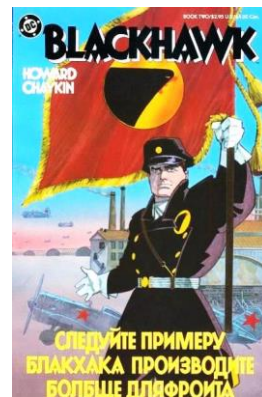

*'The greatest threat to disinformation ever known!'*

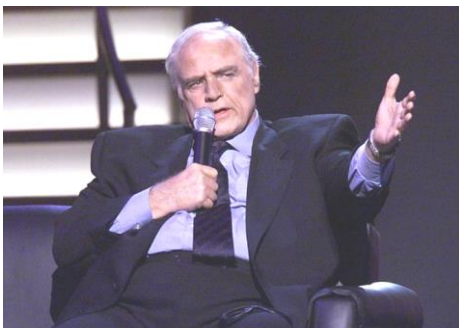

*'Son, you've never understood me. Or Jay-Jay.'*

*'The **Blackhawks** have been stopping wars*



*'I want to stop my son from killing people! He's going to commit mass murder!'*

*'My son, born Jay-Jay the Third.'*

and saving lives since before I was born!  
Trust them, trust me, trust your own blood!

Through grandfatherly inspiration  
becomes the 'Archangel of  
Vengeance'  
He's got this team, this fire to remake our  
world...!

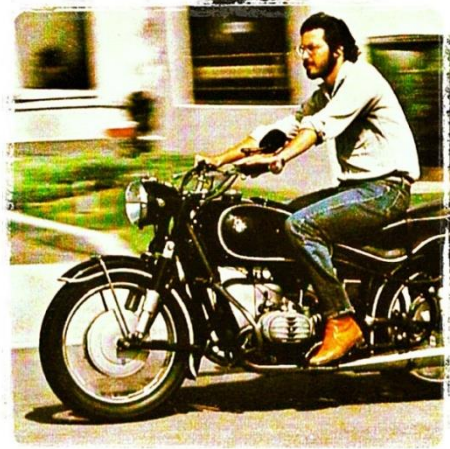
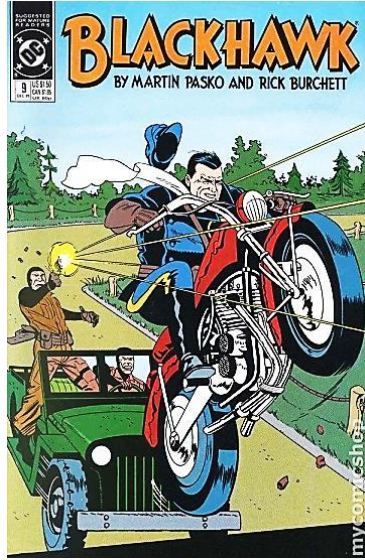

'His is the **Kid Blackhawk Generation!**'



Throughout Middle East history, Christians, Muslima and Jews have fought with a sense of 'divine duty'. Russian atheists saw *opportunity*. Syria was a longtime arms customer in need of help.

Russia helped in a big way with 34 fixed-wing aircraft -12 Su-25s; 12 Su-24M2s; four Su-30SMs; and six Su-34s. Better to bomb the rebels, better to keep the brutal Syrian regime breathing, making for a stronger, deeper Russian foothold.





Latakia, a port city on the Med, was chosen to be a forward air operating base. And the new home of the Carpatian *Lions*, named not after a famous Red Air Force of the Second World War, but for the finest soccer team in Russia (Just ask any one of them!)



*'You will not 'engage' anyone! Nor will you 'play chicken' with the Americans, the British and never the Jews!'*

So much for the plan. When the **Blackhawks** violated Syrian air space...



*'To the jets!'*

The six *Lions* ran to the runway and fired up. Surely the Syrian *Vultures* would cover them until they reached altitude. Then the *Lions* commander saw the white puffs in the sky as early winter snowflakes. And he realized...



*'Zdrastvooyte! All Lions, abort! Shut down, get out, and run for your lives!'*



# WEAPONS MANUAL



*'One can become enthusiastic over anything. For a time I was delighted with bomb throwing. It gave me a tremendous pleasure to bomb those fellows from above.'*

Before he became the Red Baron, Manfred von Richthofen, dropped bombs. It took almost a hundred years to dream up the **CBU-97**.

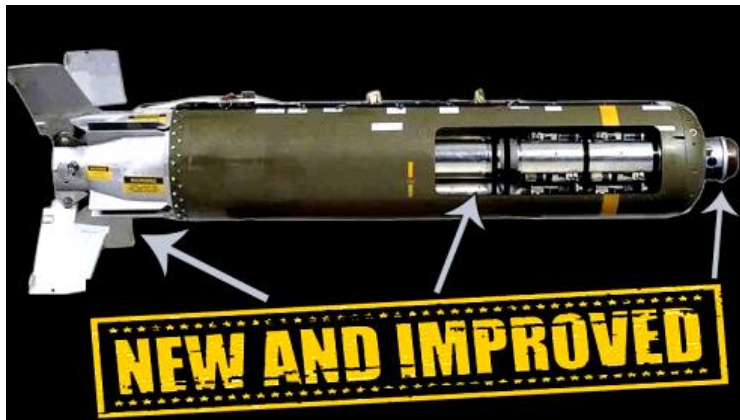

The 1,000-pound bomb consists of an SUU-66/B tactical munitions dispenser containing 10 BLU-108 submunitions. Each submunition contains four hockey-puck-shaped sensor-fused projectiles called *Skeets*.

The bomb is dropped. At a programmed altitude it bursts like a flower's ovule popping seeds, four to a parachute.

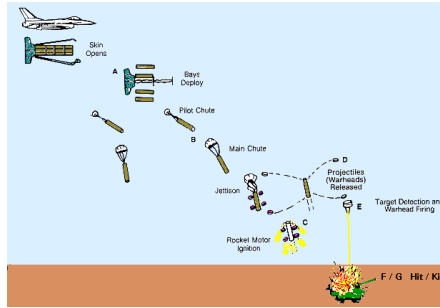
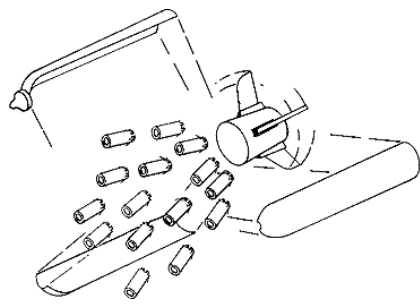

Sensors scanning for *metal* - military hardware.



Detected and locked on, the *Skeets* fire a kinetic energy penetrator down at their targets with devastating results.



However, if the descending *Skeet* finds no target, it will land harmlessly and go inert. Strictly an anti-*weapon* bomb.

In the First World War, the 'Red Baron' held the record: 80 'kills'.

The 'kill' record for *one CBU-97*: 40 tanks.

Both were made to be broken.

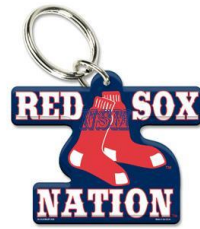

*'I am an historian. With the exception of being a wife and a mother, it is who I am. And there is nothing I take more seriously. 'That includes the 'Angels of Vengeance' who started flying during FDR's second term and finished under a President who had not been elected.'*

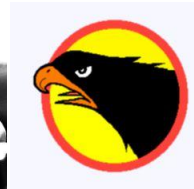

*'At the heart, theirs had been a team story, written and rewritten for 75 years!'*

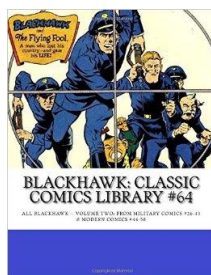
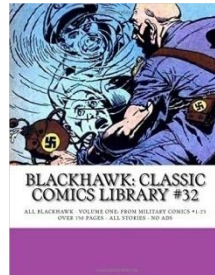
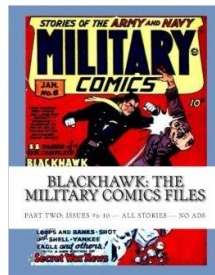
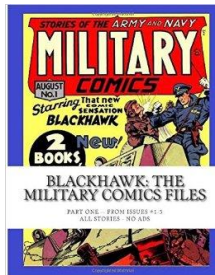

*'And there are a number of chapters...'*

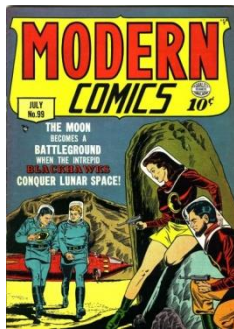

*'...That read like dime store novels that once made legends come to life!'*

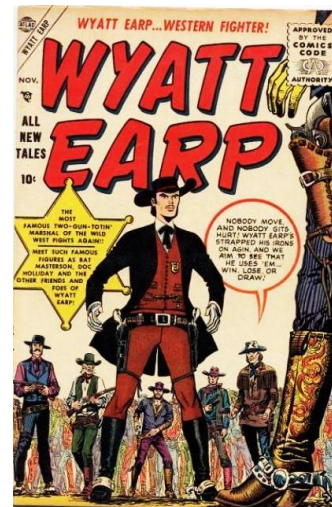
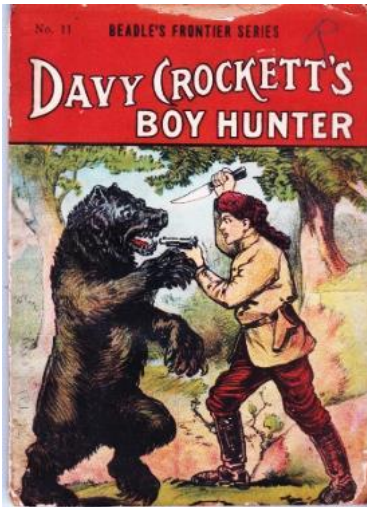

*'And after the team retired, 'revisionists' issued 'tribute' tales.*



*'What to believe? Are the reborn 'Angels of Vengeance' as fearless and as skilled, as resourceful and determined as their legendary predecessors?*

*"The once-fabled 'team' has become a community. People of different ages, colors, creeds and countries. Men and women 'fighting for liberty', but down the road, as history plays out, the **Blackhawks** who will have the biggest impact: the children!"*



**"Have you ordered your t-shirts yet?"**



*'My God! They're taking out the entire base!'*



*'CBU-97s! The Blackhawks are getting their money's worth.'*

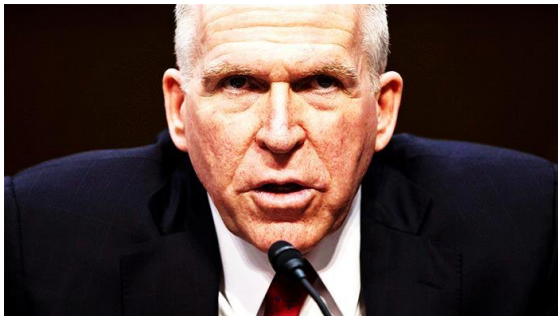

*'A million bucks apiece! And we sold them a hundred plus JDAAMs and AMRAAMs! A billion in all!'*



*'We armed the "Angels of Vengeance"?'*



*'Damn right we did! Because if we hadn't, somebody else would have.'*



*'Don't even think 'scandal'! There are hundreds, thousands around the world who owe their lives, their families' lives to the **Blackhawks!**'*



*'That was then. Now, there are going to be serious consequences!'*



*'Let there be! The Syrian regime has murdered tens of thousands of their own people, and finally something got done about it!'*



*'But the **Blackhawks** will be condemned by half the world!'*



*'Let'em holler! There's a grassroots movement swelling up in the free half of the world!'*



# **BLACKHAWK** **NATION!**



*'The economy, immigration, national debt and abortion are suddenly late night, scroll-down sound-bytes.'*

*'The Election Question - Do you, or do you not, support the "Angels of Vengeance"?''*



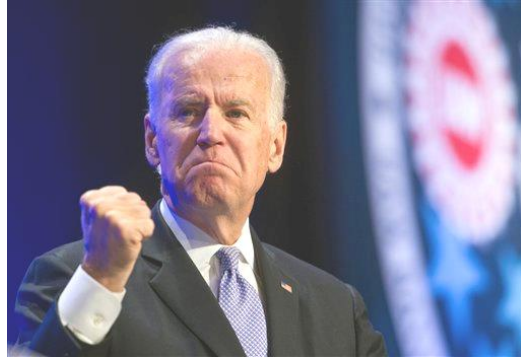
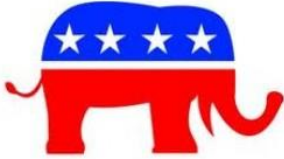

"Show me *Blackhawk!*"

***CenterCityChronicle.com***  
**AN AIR FORCE DESTROYED**



**18 SYRIAN SOLDIERS KILLED**

**f Shelley** 



'Shalom-

*'I'm supposed to be happy because the team has returned safe and sound.*

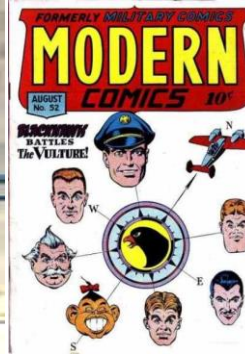

*'But I'm not because I helped my grandfather kill people.'*



*'We Kid Blackhawks are united, and if we had stood up together and said, "We don't want the 'Angels of Vengeance' to bomb and kill anymore..."'*

*'But none of us did. We knew, we believed that new Russian weapons in Syria were meant to prolong the Civil War that has already killed 250,000 - A Blackhawk target!'*

*'We are going to change the world! And we will do what must be done.'*

*'To the dictators and tyrants, warlords and drug lords, slavers and terrorists who are stealing and killing and raping and exploiting...'*

*'We are the 'Angels of Vengeance' and we will show you Blackhawk!'*



**HAWK-A-A-A-A!**

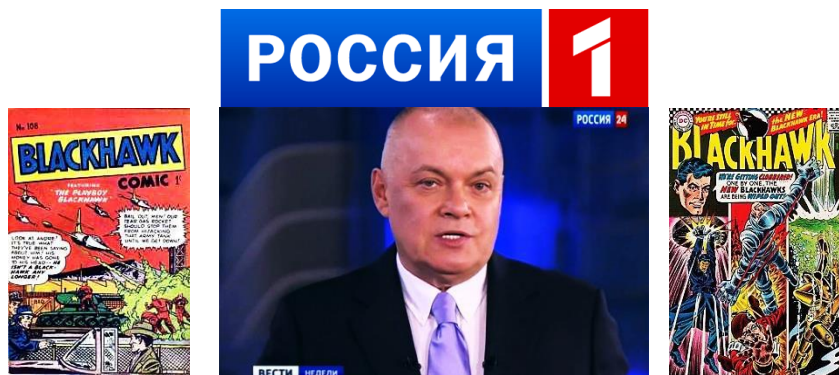

*"A dastardly sneak attack upon the sovereign state of Syria by flying terrorists, equipped and directed by their former employers, the United States of America!"*



*"Must Russia alone take action against these airborne murderers? Has the rest of the world no backbone against these 'Angels of Vengeance'?"*

*"The Carpathian Lions, whose planes were destroyed on the runway by Blackhawk terror bombs..."*

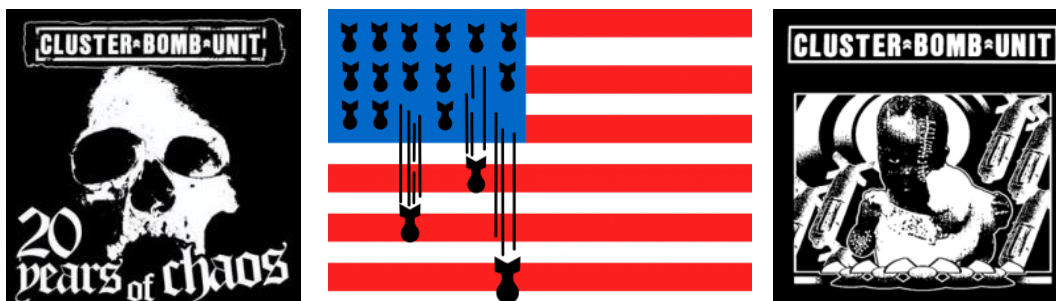

*"And the Kremlin Knights, our finest fighter squadron, has sworn to end the reign of these 'Angels of Vengeance'!"*





***"The deaths of our Syrian comrades will be avenged!"***



After the team got back...



*'Bashar al-Assad no longer has an air force to bomb his people!'*



*'And the Russians will think twice about supporting him!'*





*'Another positive step on the road to World Peace!'*

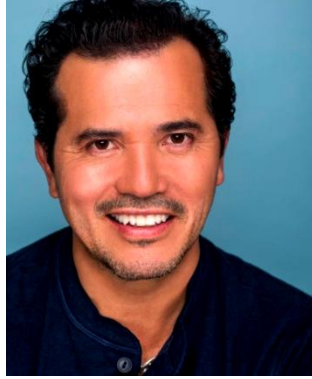

*'And with every mission, yet another "step"!'*



*'We keep this up, we'll fly ourselves out of a job!'*



*'We **Kid Blackhawks** have begun our own mission.'*



*'You've made the 'Angels of Vengeance' the #1 Team!'*

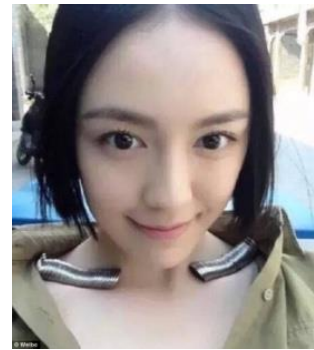

*'We're going to market our brand!'*

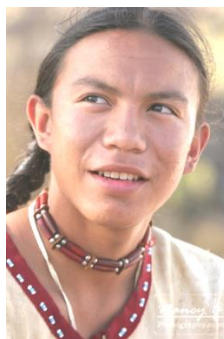

*'We're starting t-shirt factories around the world.'*



*'A full team wardrobe!'*



*'Blackhawk fashion, sneakers and boots! We're taking bids!'*



*'That "Angel of Vengeance" look! I believe we Lady Blackhawks will have something to say about that!'*



*"And the toys are coming back...with a vengeance!"*



*'Who put up the capital for this international endeavor?'*

*'We have our own "Angel".'*

*'What do you plan to do with the profits?'*



*'Off-shore accounts.'*



*'Thank you! Zinda and I have never been happier. We...'*



*'But wait! There's more.'*



*'We submitted a screenplay.'*



*'Awaiting...'*

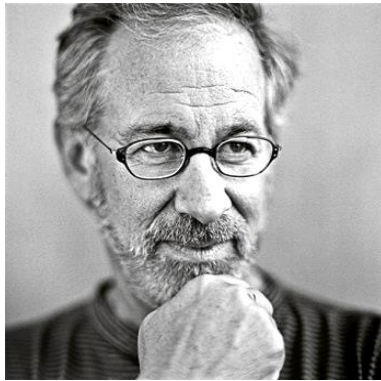

*'Zinda, I know just the actress!'*



*'And I have the hero for you!'*





*'Sorry, just bit-parts.'*



*'Our major motion picture is the definitive story.'*



*'Starring the reason we're here... 'Junior' Johnson!'*

# **KID BLACKHAWK** *'Young Angel of Vengeance'*



# Epilogue

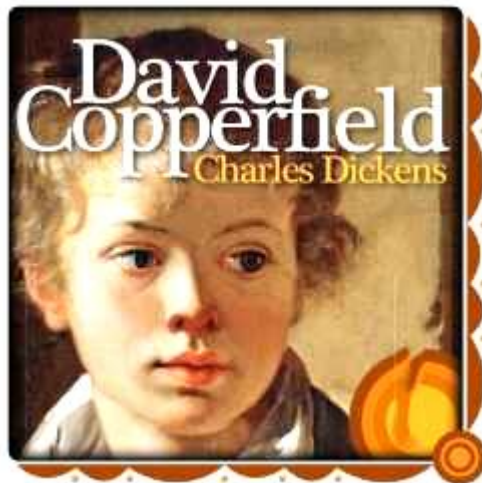

*“Whether I shall turn out to be the hero of my own life,  
or whether that station will be held by anybody else, these  
pages must show.”*

f Abasi 🐦



"As-salam alaykum-

"Great news! I am no longer the youngest Kid Blackhawk! That esteemed honor belongs to my new baby brother!



'His name is 'Junior'. The firstborn on *Blackhawk Island* had to be named 'Junior'!

And in the years to come, this latest young "Angel of vengeance" is going to show the whole world *Blackhawk*!

**HAWKA-A-A-A!**

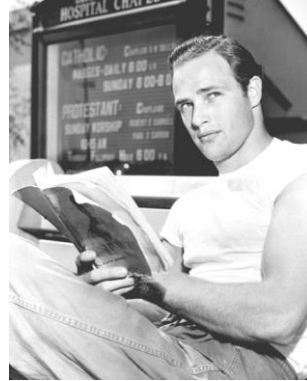

## Real Time

### My Journal:

*A great day! Took me way back. Then it got even better; my son called.*

*'I'm sorry, Dad,' he says. 'You were right and I was wrong and I apologize. Because you believed, my son believed, and now I believe, in Blackhawk.'*

*'But they've made enemies all over, what will they do next?'*

*'Not my call, I can't wait,' I say. 'Thank you, thank you for calling.'*

*Yet again, my son showed me JJ2. Good for him!*

*The older I get, the days seem shorter and the nights longer. Waking up in the morning can take till noon.*



*My Life has been a wonderful flight and I'll be visiting Blackhawk Island again very soon, I can feel it in my bones.*

*AT SUNRISE, TEARS FILL THE EYES OF THE BLACKHAWKS AS THEY PAY THEIR LAST RESPECTS TO THEIR LEADER...*



*I want to deliver the eulogy at Blackhawk's funeral! When the time comes I want everyone to understand that the spirit he felt, that inspired so many, still burns hot and bright!*

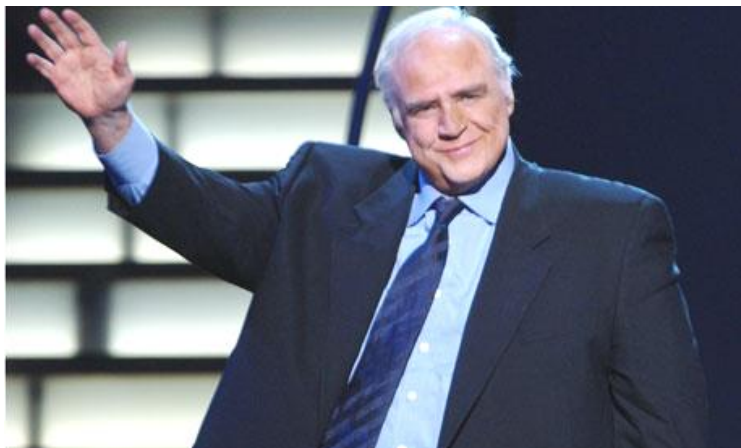

*Taking my meds, taking it easy. Time for a long happy nap. Not only have my dreams come true, they will outlive me.*

**"HAWKA-A-A-A!"**  
*'Junior' Johnson*

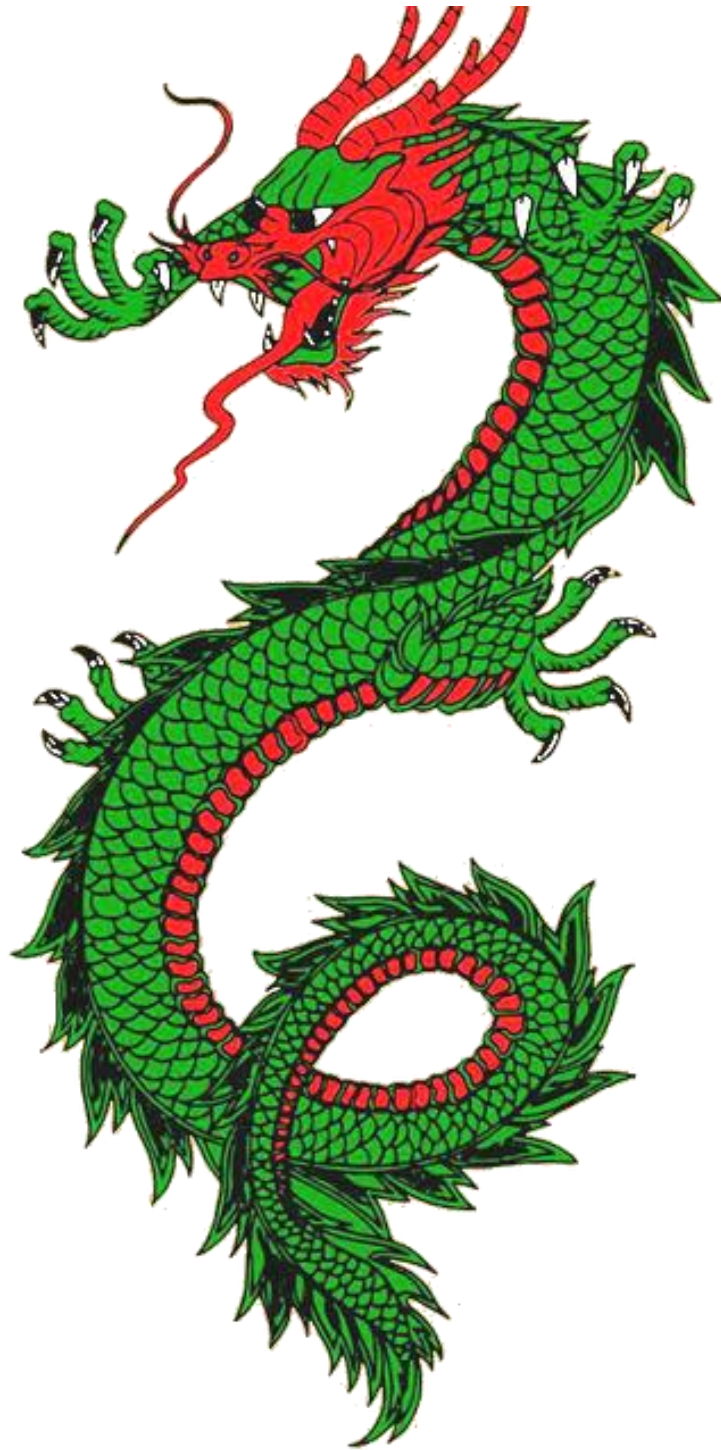

# **Date With A DRAGON!**